

Photoelectric sensor
Z2 Series

20meter type : Z2T-2000 Thru-beam
 4meter type : Z2R-400 Retro-reflective
 80cm type : Z2D-80 Diffuse-reflective



Best-in-class Photosensors realized by high power LED.

3 basic types with sensing distance of 20 meter (thru-beam)

Have a look at
 Z series brochure, too.

Z2 series Products

Model		Thru-beam	Retro-reflective	Diffuse-reflective
Cable Type	NPN	Z2T-2000N	Z2R-400N	Z2D-80N
	PNP	Z2T-2000P	Z2R-400P	Z2D-80P
M8 QD Type	NPN	Z2T-2000CN4	Z2R-400CN4	Z2D-80CN4
	PNP	Z2T-2000CP4	Z2R-400CP4	Z2D-80CP4
Detecting distance		20m	0.01~4m	0~80cm



Dimensions (mm)

Cable type

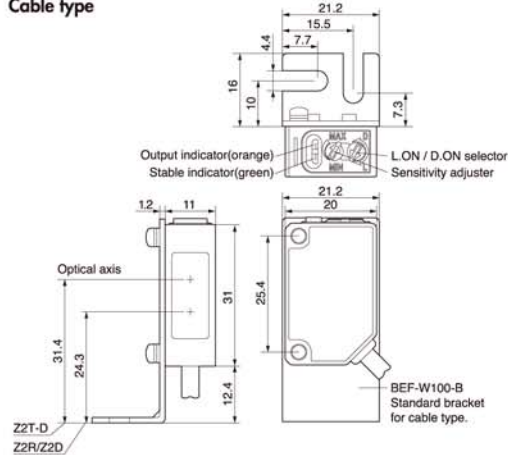

M8 Connector type

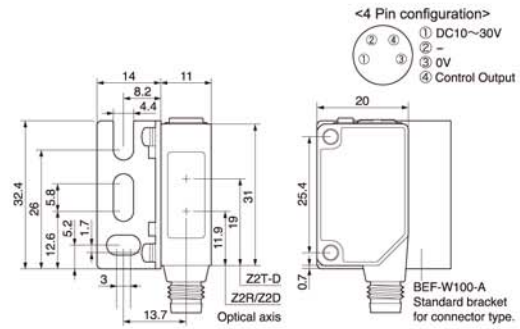

Circuit diagram

NPN output

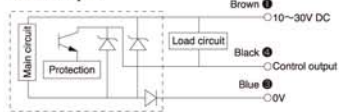

PNP output

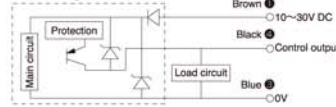

Emitter of Thru-beam type

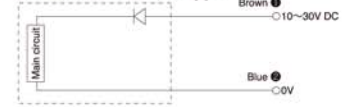

Spot size

Z2T-2000

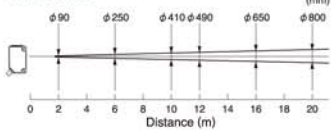

Z2R-400

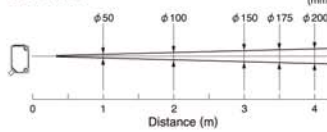

Z2D-80

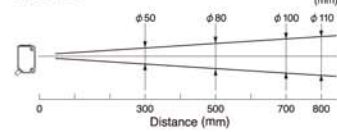

Specifications

Model	Thru-beam	Retro-reflective	Diffuse-reflective
Cable type	Z2T-2000(N,P)	Z2R-400(N,P)	Z2D-80(N,P)
M8 QD type	Z2T-2000C(N4,P4)	Z2R-400C(N4,P4)	Z2D-80C(N4,P4)
Sensing distance	20m	0.01~4m ※1	0~80cm ※2
Response time	500μs max.		
Spot size	φ800mm @ 20m	φ200mm @ 4m	φ110mm @ 80cm
Operating mode	Light ON / Dark ON selectable		
LED Indicator	Output : orange, Stable : green		
Light source	Red LED		
Sensitivity adjustment	1-turn volume		
Control output	NPN or PNP Open collector, 100mA Max. DC30V Max. (Residual voltage 1.8V Max.)		
Supply voltage	DC10-30V including 10% ripple(P-P)		
Power consumption	Sender : 20mA Max. Receiver : 15mA Max.	20mA Max.	
Protection category	IP67		
Shock Resistance	100G		
Vibration Resistance	10-55Hz, 15mm X,Y,Z, each. 2 hours		
Ambient temp. / humidity	-25~55°C / 35~85% RH (No condensation or freezing)		
Storage temp. / humidity	-40~+70°C / 35~95% RH (No condensation or freezing)		
Material	Case : ABS (glass included) Front Cover , Lens : PMMA		

※1. Reflector V-61

※2. White 90% 100mm×100mm

● Specifications are subject to change without prior notice.

● Specifications and technical information not mentioned here are written in Operation Manual. Or visit our website for details.

● All the warnings and cautions to know prior to use are given in Operation Manual.

OPTEX
FA OPTEX FA CO., LTD.

Ramco Innovations
Optex Fa US Sales
Phone 800-280-6933
web www.optex-ramco.com