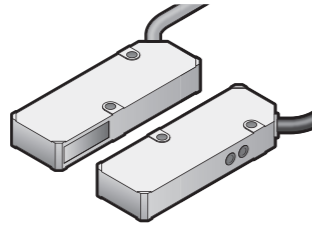

Through-beam Edge Sensor

TD1 Series

TD1-010M8

OPTEX FA CO., LTD.

- Thank you for purchasing this Through-beam Edge Sensor TD1 series.
- Before using this product, please read this manual carefully to ensure proper use.
- Read this manual thoroughly, and then keep this manual at hand so that it can be used whenever necessary.
- The warranty period of this product is one year after delivery. However, any fault attributable to natural disasters or any other similar disasters or modification or repair will be excluded from the scope of the warranty.
- When exporting a device in which this product is embedded to an EU nation*, the EU Battery Directive applies even to embedded devices, so we ask that you provide the following support.
 - When exporting a product to an EU nation*, include the latest instruction manual of this product. If it is not possible to include the instruction manual of this product, write the section <Symbol mark explanation> in the device's manual.
 - *: The term EU nation includes Switzerland, Ireland, Norway, Liechtenstein, and Turkey in addition to the member nations of EU.

Safety Precautions

Safety precautions for ensuring safe operation of this product are displayed as follows with the following symbols.

Precautions listed here describe important information about safety. Make sure to follow them accordingly.

Safety Symbols

	WARNING	Indicates that any improper operation or handling may result in moderate or minor injury, and in rare cases, serious injury or death. Also indicates a risk of serious property damage.
	CAUTION	Indicates that any improper operation or handling may result in minor injury or property damage.

		WARNING
		This product cannot be used as protective equipment for the purpose of protecting the human body.
		Do not disassemble, repair, modify, deform under pressure, or attempt to incinerate this product. Doing so may cause injury or fire.
		Do not use this product in water or in a location where it may be exposed to water. Do not use this product if wet. Doing so may cause a fire or damage the product.
		This product is not explosion-proof and should not be used around flammable or explosive gases or liquids. Doing so may cause ignition resulting in an explosion or fire.
		Do not use air dusters or any spray that uses flammable gas around the product or on the inside of the product. Doing so may cause ignition resulting in an explosion or fire.
		Do not install this product in any of the following locations. Doing so may cause a fire, damage, or a malfunction. <ol style="list-style-type: none"> 1. Locations where dust, salt, iron powders, or vapor (steam) is present. 2. Locations subjected to corrosive gases or flammable gases. 3. Locations where oil or chemical splashes may occur. 4. Locations where heavy vibrations or impacts may occur. 5. Locations where the ambient temperature exceeds the rated range. 6. Locations subject to rapid temperature changes (or where condensation occurs). 7. Locations with strong electric or magnetic fields. 8. Outdoor locations or locations subject to direct light.
		Do not use the product at voltages or with AC power supplies that exceed the rated voltage. Doing so may cause a fire or damage the product.
		Do not use this product in a non-industrial setting. Doing so may cause induction or radiation interference.
		This product is not intended for use with nuclear power, railways, aviation, vehicles, medical equipment, food-handling equipment, or any application where particular safety measures are required. Absolutely do not use this product for any of these fields.
		This product cannot be used in applications that directly or indirectly detect human bodies for the purpose of ensuring safety. Do not use this product as a detection device for protecting the human body.
		What to do in the event of a malfunction such as smoke being emitted from the product If you detect any malfunction including emission of smoke, abnormal smells or sounds, or the body becoming very hot, immediately stop operating the product and turn off the sensor power. Failure to do so may cause a fire. Repairing the product is dangerous and should in no way be performed by the customer. Contact an OPTEX FA sales representative for repairs.
		What to do if water enters the product If water or any other liquid enters the product or the cable, immediately stop operating the product and turn off the power. Using the product in this condition may cause a fire.

CAUTION

- Make sure to turn the power off before wiring the cable or connecting/disconnecting the connector. Connecting or disconnecting while energized may damage the product or cause electric shock.
- Avoid wiring in parallel with or in the same piping as high-voltage wires or power lines. Doing so may cause malfunction or damage by induction.
- Do not bend the cable when below the freezing point. This may cause the cable to break.
- Do not drop the product or subject the product to strong impacts. Doing so may damage the product.
- Follow the instructions in this manual or the specified instruction manual when wiring the product or the dedicated controller for the correct wiring method. Incorrect wiring can damage the product or the controller, or cause a malfunction.
- When disconnecting the connector, be careful not to touch the terminals inside the connector, and do not allow foreign objects to enter the connector.
- Install this product as far away as possible from high-voltage equipment, power equipment, equipment that generates large switching surges, inverter motors, welders, or any equipment that can be a source of noise.
- When connecting or disconnecting the cable, make sure to hold it by the connector portion, and do not apply excessive force to the cable.
- Do not touch the product or the cable with wet hands. Doing so may damage the product.
- Use the dedicated cable for connecting the product. Use of anything other than the dedicated cable may cause a malfunction or damage the product.
- Tighten the sensor head mounting screws (included screws or the like) with a tightening torque of no more than 0.5N·m. Excessive tightening torque may damage the sensor head.
- Use the product and dedicated controller within the rated ranges.
- Do not excessively twist or apply stress to the cable. Doing so may damage the cable or its connector.
- Install the product and the dedicated controller securely. Failure to ensure secure installation may result in the product falling and becoming damaged.
- During operation, this product becomes very hot. Do not touch it for long time. Doing so may cause a low-temperature burn.
- After changing the settings, wait for at least 3 seconds before turning this product off.

Precautions for Laser Use

- This product emits a Class 1 visible laser beam that is compliant with JIS C6802/IEC 60825-1 laser product safety standards.
- If this product is to be exported to the United States, it is necessary to follow laser standards as stipulated by the American Food and Drug Administration (FDA).
- Do not allow a laser beam to enter an eye, either directly or reflected from a reflective object. Short-term visual disturbances such as flash-blindness and after-images may result from direct-beam viewing.
- If installing this product in your own equipment, ensure that the product is properly handled according to the laws and regulations of the relevant country or region.
- This product does not have a function that stops the emission of light from the laser during disassembly. Do not disassemble the product.
- Do not disassemble or modify this product. Using the product after it has been modified may cause induction and radiation interference.

NOTICE

- After carefully considering the intended use, required specifications, and usage conditions, install and use the product within the specified ranges.
- All specifications may be changed without notice.
- When using this product, it is the responsibility of the customer to ensure necessary safety designs in hardware, software, and systems in order to prevent any threat to life, physical health, and property due to product malfunction or failure.
- Do not use this product for the development of weapons of mass destruction, for military use, or for any other military application. Moreover, if this product is to be exported, comply with all applicable export laws and regulations, including the "Foreign Exchange and Foreign Trade Act" and the "Export Administration Regulations," and carry out the necessary procedures pursuant to the provisions therein.
- Before using this product, fully examine the applicable environmental laws and regulations, and operate the product in conformity to such laws and regulations. OPTEX FA does not assume any responsibility for damages or losses occurring as a result of noncompliance with applicable laws and regulations.

1. Included Accessories/Options

Included Accessories

- Instruction manual (this manual)
- Sensor/amplifier connection cable (Y branch cable)
Model: TDCN-Y2-M8

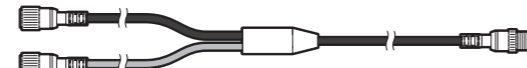

- Cable with M8, 4-pin connector for connecting the sensor and the amplifier unit (Y branch cable)
- Up to two sensor sets can be connected to one amplifier.
- Cable length: 2 m

Options

- Amplifier Unit
Model: CDA-M

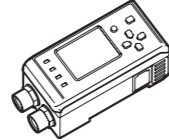

This product is used while connected to the amplifier unit CDA-M. Connecting to a CDA-M makes it possible to use the following functions.

- Displaying the settings and measured values (See "5. Setting Menu Overview" on the back side.)
- Analog and control output (See the CDA series instruction manual.)

- Sensor/amplifier connection cable (straight cable)
Model: DSL-0804-G02M (Cable length: 2 m)
Model: DSL-0804-G05M (Cable length: 5 m)



- Cable with M8, 4-pin connector for connecting the sensor and the amplifier unit (straight cable)
- Two cables are required for one sensor set.
- One sensor set can be connected to one amplifier.
- This can also be used as an extension cable for the TDCN-Y2-M8 (Y branch cable). Ensure that the overall cable length between the TD1 series and the CDA-M amplifier unit is within 10 m.

2. Dimensions

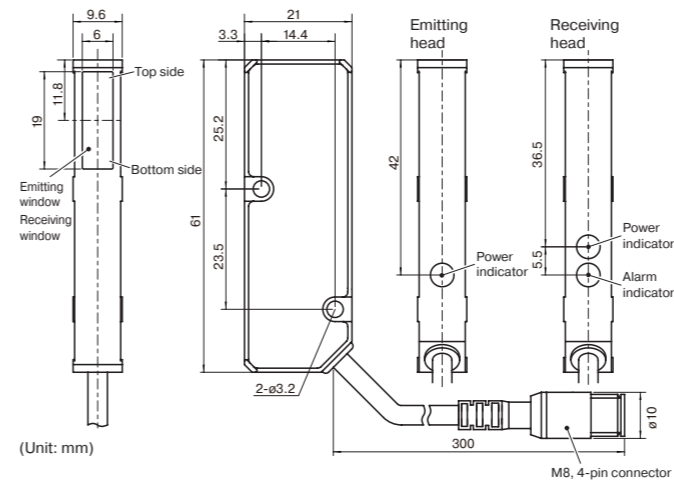

(Unit: mm)

Pin No.	Wire color	Function	
		Emitting head side	Receiving head side
(1)	Brown	12 to 24 VDC ±10%	
(3)	Blue	0 V	
(4)	Black	(N.C.)	RS-485 (A)
(2)	White	(N.C.)	RS-485 (B)

[Emitting head side] [Receiving head side]

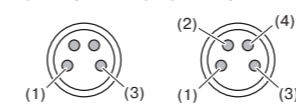

3. Connecting and Mounting

Connecting

With a Y branch cable

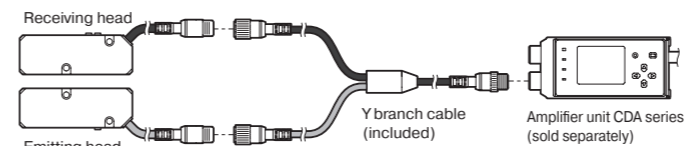

- When using a Y branch cable, connect the cables with the same colors to each other.

With straight cables

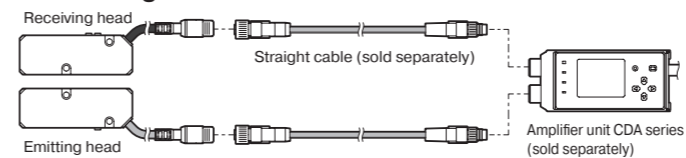

- Using Straight cable, the measured value is displayed on the channel of the side to which the receiving head is connected.
- Perform installation so that the minimum bend radius of each cable is 30 mm or more.

Mounting Method

Use the head reference surfaces as a guide to align the light axis between the emitting and receiving sides when mounting this product.

If it is difficult to align the reference surfaces due to factors such as the conditions of the installation position, check the light axis according to **Direction Checking** on the back side.

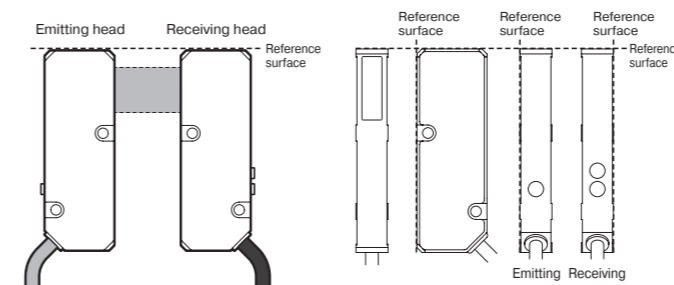

Examples of incorrect mounting

Inverted mounting

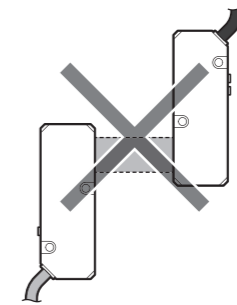

Mounting in a position where light enters the receiving head directly

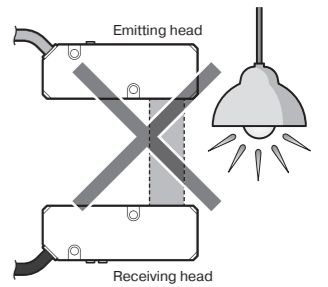

Mounting with the light axis misaligned

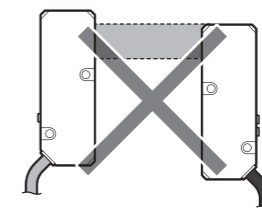

Tilted mounting

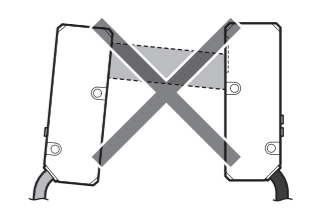

CHECK! See **Direction Checking** on the back side and adjust the light axis so that the mounting positions become correct.

- If you mount this product as shown above, it may not be able to perform accurate measurements.

4. Specifications

Model	TD1-010M8	
Measurement range	Edge: ±5 mm, width: 10 mm	
Distance between heads	Max. 300 mm	
Light source	Medium (Wavelength) Red semiconductor laser (Wavelength: 660 nm)	
Maximum output	390 μW	
Laser class	CLASS 1 (IEC/JIS)*1	
Spot size	3 × 14 mm	
Linearity	With a distance between heads of 100 mm: ±0.4% of F.S. (±40 μm)	
Repeatability*2	±5 μm	
Sampling period	500 μs	
Temperature drift	±0.02% of F.S./°C	
Indicators*3	Emitting head, Power indicator: green Receiving head, Power indicator: green, alarm indicator: red	
Serial interface	RS-485	
Supply voltage	12 to 24 VDC ±10%	
Current consumption	Emitting head: 20 mA or less (at 12 VDC) Receiving head: 80 mA or less (at 12 VDC)	
Connection type	Pig tail type: Cable with M8, 4-pin connector, 300 mm length	
Protection circuit	Reverse connection protection	
Environmental resistance	Degree of protection	IP50
	Ambient temperature/humidity	-10 to +50°C/35 to 85%RH (no freezing or condensation)
	Storage temperature/humidity	-20 to +60°C/35 to 85%RH (no freezing or condensation)
	Ambient illuminance	Sunlight: 10,000 lx or less, incandescent lamp: 3,000 lx or less
Applicable regulators	Vibration resistance	10 to 55 Hz; double amplitude 1.5 mm; 2 hours in each of the X, Y, and Z directions
	Shock resistance	Approx. 50 G (500 m/s ²); 3 times in each of the X, Y, and Z directions
	EMC	EMC directive (2014/30/EU)
Applicable standards	Environment RoHS directive (2011/65/EU), China RoHS (MIT Order No. 32)	
Weight	EN 60947-5-2	
Material	Emitting head, receiving head: 30 g each (including 300 mm connector cable) Housing: aluminum die cast, emitting/receiving part: glass	

*1 Contact OPTEX FA for information on FDA Regulations.

*2 With an averaging count of one

*3 For the lighting status of the indicators, see **Direction Checking** on the back side.

- Support for the China RoHS directive
- For details on the support for the China RoHS, see the following website.

https://www.optex-fa.com/rohs_cn/

- Specifications are subject to change without notice
- For more information, questions and comments regarding product, please contact us below.

5. Setting Menu Overview

Amplifier unit channel selection menu

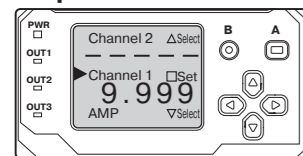

[To the TD1 series menu]
Select the channel for which the settings will be changed.
[To the amplifier unit menu]
Select "AMP."

• For details on how to change the amplifier unit settings, see the CDA series manual.

△ button: Select/ □ button: Set

TD1 Series Top Menu

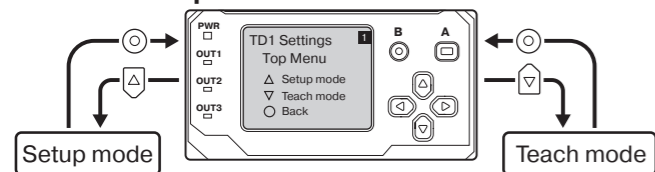

Procedure of Setup mode

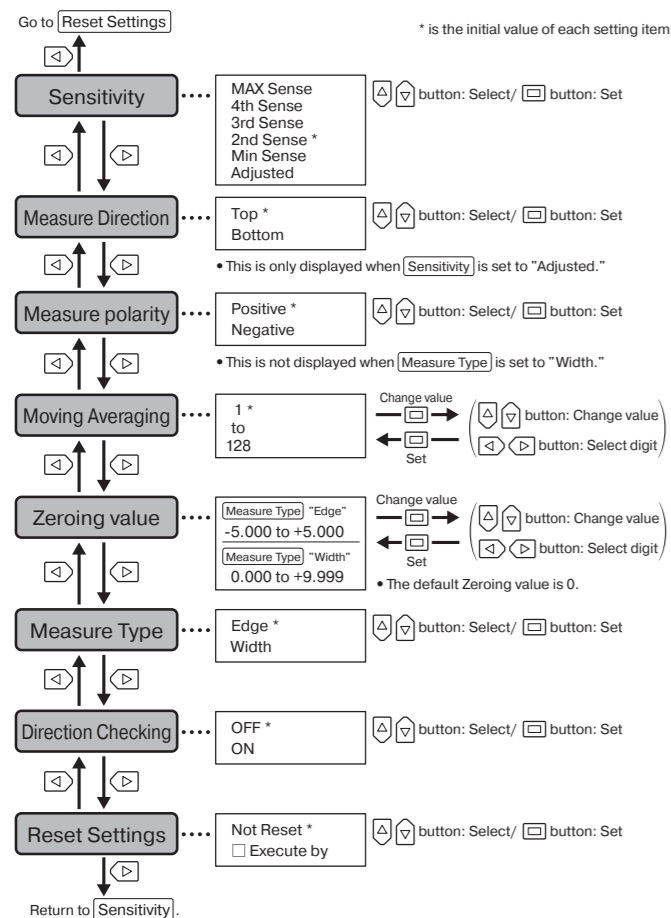

Procedure of Teach mode

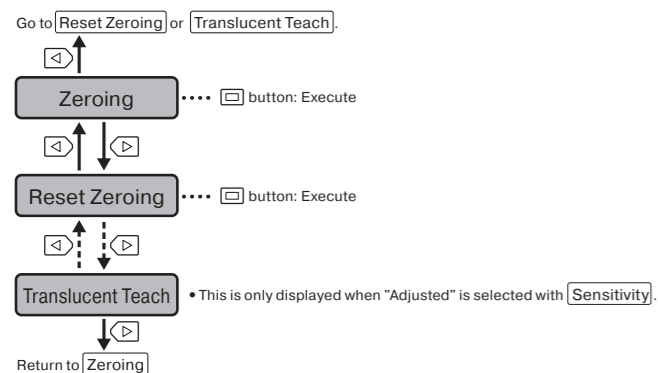

6. Setting Item Details

Details on Setup mode

Measure Type

There are two types: "Edge" (single edge measurement) and "Width" (width or gap measurement).

To measure the edge of the target

Use Measure Type to select "Edge."

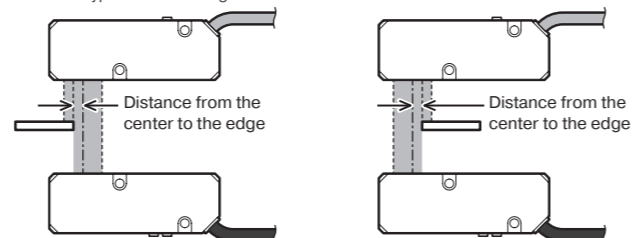

The displacement from the center of the light axis for a single edge is measured. The target insertion direction can be set to either Top or Bottom. Measurement cannot be performed if two or more edges exist within the measurement range.

To measure the target width or the gap between targets

Use Measure Type to select "Width."

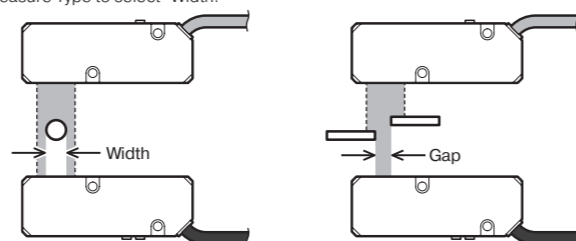

The distance between two edges will be measured. You can measure either the target width or the gap between two targets. Measurement cannot be performed if only one edge exists or three or more edges exist within the measurement range.

• With the CDA-M amplifier unit, if the measurement target does not exist, "9999" is displayed (with the character and background colors inverted) with complete light detection and "-9999" is displayed when the light is completely blocked.

Measure polarity

Select whether to set the top side to -5.000 mm and the bottom side to +5.000 mm or vice-versa when measuring edge positions. [Measure polarity] is only enabled during "Edge" measurement.

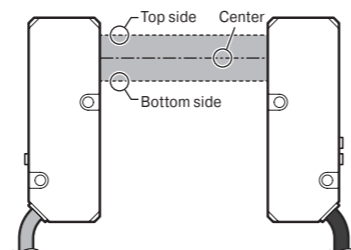

Values when "Positive" is selected: top side: -5.000 mm, bottom side: +5.000 mm, center: 0 mm
Values when "Negative" is selected: top side: +5.000 mm, bottom side: -5.000 mm, center: 0 mm

Moving Averaging

Moving average processing will be applied to the measured value for the specified number of times. You can set a value in the range of "1" to "128." If you specify a value of "1," average processing will not be performed. When measurement is not possible, the moving average processing is not updated.

Zeroing value

Check and change the Zeroing value.
• Settable range
"Edge" measurement: -5.000 to +5.000
"Width" measurement: 0 to +9.999

Direction Checking

You can check for and adjust the misalignment of the light axis in relation to the top and bottom directions when installing the heads.

Switching [Direction Checking] to "ON"

- For the operation method, see "5. Setting Menu Overview."
- After you finish adjusting the light axis, switch [Direction Checking] to "OFF."

If you return to the measured value display with this set to ON, measurement will not be possible, so the measured value will be displayed as "0000" or "9999."

With [Direction Checking] set to "ON," the Power indicator and alarm indicators of the receiving head light and flash according to the light receiving status.

When light is received correctly, the Power indicator (green) and alarm indicator (red) on the receiving head both light.

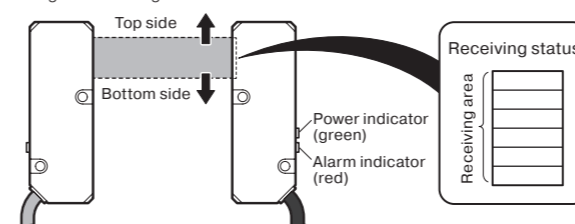

Misaligned to the top side

Misalignment	Receiving status	Display
Large	Receiving area: Full lit	Power indicator (green): Lit continuously ☀
	Receiving area: Partial lit	Alarm indicator (red): Not lit ●
	Receiving area: Full lit	Power indicator (green): Lit continuously ☀
Small	Receiving area: Full lit	Power indicator (green): Lit continuously ☀
	Receiving area: Partial lit	Alarm indicator (red): Flashing slowly ⚡
	Receiving area: Full lit	Power indicator (green): Lit continuously ☀

[Countermeasure]: Move the light axis to the bottom side.

Misaligned to the bottom side

Misalignment	Receiving status	Display
Small	Receiving area: Full lit	Power indicator (green): Flashing quickly ⚡
	Receiving area: Partial lit	Alarm indicator (red): Lit continuously ☀
	Receiving area: Full lit	Power indicator (green): Flashing slowly ⚡
Large	Receiving area: Full lit	Power indicator (green): Flashing slowly ⚡
	Receiving area: Partial lit	Alarm indicator (red): Lit continuously ☀
	Receiving area: Full lit	Power indicator (green): Not lit ●
	Receiving area: Full lit	Alarm indicator (red): Lit continuously ☀

[Countermeasure]: Move the light axis to the top side.

Misaligned by half or more

Receiving status	Display
Receiving area: Full lit	Power indicator (green): Not lit ●
Receiving area: Full lit	Alarm indicator (red): Not lit ●

Sensitivity

You can set the sensitivity to one of five levels. Normally, there is no problem with using this product with its default value of "2nd Sense" However, if measurements are unstable, such as due to a large distance between the emitting and receiving sides, increase the sensitivity level.

Also, lower the sensitivity level if measurements are unstable due to the laser light passing through the measurement target.

If the measurement target has a high transmittance and changing the sensitivity setting does not stabilize the measurement, select "Adjusted" with [Sensitivity], and then execute [Translucent Teach] from the Teach mode menu.

This performs adjustments to match the installation status, enabling measurements of targets with transmittance of up to approximately 80%.

- "Adjusted" can only be selected when measuring edges.

Measure Direction

Set the target insertion direction when measuring the edges of transparent objects with [Sensitivity] set to "Adjusted."

Reset Settings

All setting items are returned to their factory default settings.

7. Teach mode

Details on teach mode

When you select [Zeroing], position the measurement target at the location where you want to set the displayed measured value to 0. When you select [Translucent Teach], keep the measurement target out of the measurement range. Then, press the □ button.

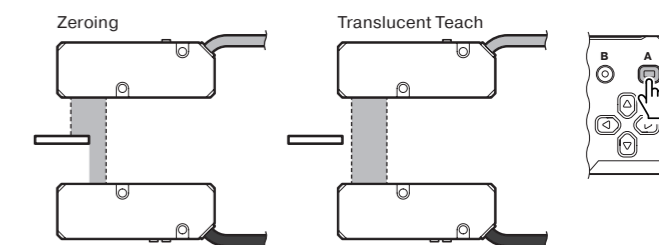

Zeroing

The current measured value is set as the offset value, and the current displayed measured value is set to 0.

Reset Zeroing

The Zeroing value is cleared. The measure value is returned to its current value.

Translucent Teach

Use this when "Adjusted" is selected with the [Sensitivity] setting item and edges of transparent objects are being measured.

Perform teaching with the measurement target outside of the measurement range. The sensitivity will be adjusted to the optimal value.

However, detection may not be possible in the case of highly transparent objects.

OPTEX FA CO.,LTD.

[Headquarters]
91 Chudoji-Awata-cho Shimogyo-ku Kyoto 600-8815 JAPAN
TEL +81-75-325-1314 FAX +81-75-325-2936

<https://www.optex-fa.com>